

We build a better future

Robex 9 1200-9



*Photo may include optional equipment.

THE OFFICIAL DEALER OF HYUNDAI
«TYAZHPROMINVEST» (TPI, LLC)
105082 MOSCOW STREET B.POCHTOVAYA D.26/1 OFF.605

+7 (495) 782-73-79
+7 (800) 550-73-35

WWW.T-P-I.RU

 **HYUNDAI**
HEAVY INDUSTRIES EUROPE

Pleasure works

An operator, who takes pleasure in his work, does a better job. That is why we at Hyundai Heavy Industries do everything we can to make that happen. We merged operator preference, fast precision and lasting performance into a quality product. Hyundai 9 series earthmoving equipment simply makes time fly, makes pleasure work!



*Photo may include optional equipment.

Robex I200-9

Machine Walk-Around

Engine Technology

Powerful and reliable, fuel efficient Cummins Tier II QSK23 C engine.
Electronical controlled, clean and efficient combustion.
Low noise / Auto engine overheat prevention / Anti-restart function.

Hydraulic System Improvements

New patented hydraulic system for maximum controllability / Improved main control valve for higher efficiency and smoother operation / Auto boom vs. swing priority system for maximum speed / Auto power boost for extra power / Improved arm & boom regeneration for higher speed and better efficiency.

Pump Compartment

Powerful and reliable axial piston pumps, designed by Kawasaki.
Compact solenoid block to control: 2 speed travel, power boost, boom priority and safety lock.

Enhanced Operators' Cabin

Improved Visibility

Enlarged cabin with improved visibility / See-through sunroof for visibility and ventilation.
Large right-side window, for better visibility on foot of boom.
All windows consist of Safety glass.
Roll-up type sun visor for operators' convenience / Reduced front window seam for improved operator view.

Rigid Cabin Construction

New steel tube construction for increased operator safety, higher protection and better durability.
New front window mechanism designed with spring assist.

Improved Seat & Console

Ergonomic joysticks equipped with auxiliary buttons for attachment use.
Standard mechanic suspension with heater or optional air suspension.
New joystick consoles - adjustable in height.
Adjustable arm rests - for optimum comfort.

Advanced 7" Color Cluster

New Color LCD Display with digital gauges for hydraulic oil temperature, coolant temperature and fuel level.
Toggle switch makes it easier to tune your machine and to check diagnostics.
A new developed rear-view camera is integrated into the cluster.
3 power modes : Power / Standard / Economy, User mode for saving operators' preferences.
Enhanced self-diagnostic features with remote access through the Hi-Mate system.
Anti-theft system with password entry.
Boom speed and arm regeneration can be adjusted through the cluster.
Auto power boost in Power-mode - activated through the cluster.
Air conditioning and heater with automatic climate control.
Hi-Mate (Remote Management System) enables machine owners to follow-up machine performance, to verify machine location and to access diagnostic information on a distance through any internet connection.

Robust Undercarriage

Track chain with urethane seals / Full track rail guard / Comfortable bolt-on steps / Large upper roller cut-outs / Grease-type track adjusters.



Preference

An operator, who sets his machine to his needs, takes pleasure in his work. 9 Series respects operator preference with regards to comfort, ease-of-use and controllability. The dashboard cluster with 7 inch screen and toggle switch is the preference nerve centre.



*Photo may include optional equipment.



Spacious Cabin with Excellent Visibility

The spacious cabin is ergonomically designed with low noise levels and high visibility. Special attention was paid to create a clear, open and convenient interior with excellent visibility in all directions. This well balanced operators' environment put the operator in the perfect position to work safely and securely.

Operator Comfort

In a 9 series cabin you can adjust the seat, console and armrests to suit your preferred comfort level. Seat and console can be adjusted in position and height together and independent from each other. A fully automatic, high capacity air conditioning system maintains a constant temperature.



Stressless

Work is stressful enough; your working environment should be stressless. Hyundai's 9 series provides improved cabin interior, additional space and a comfortable seat to minimize the stress of the operator. A powerful climate control system provides the operator with his preferred air temperature. An advanced audio system with AM/FM stereo and MP3 capabilities, plus remote controls is installed to listen to your preferred music favorites. Operators can even call while operating with the hands-free mobile phone feature.



Easy to Use Cluster

The advanced cluster with 7 inch wide color LCD screen and toggle switch allows the operator to select his personal machine preferences. Power mode selection, self diagnostics, rear-view camera, maintenance check lists, start-up machine security and video functions are integrated into the cluster to make the machine more versatile and the operator more productive.



Precision

An operator, who feels his machine respond smoothly, takes pleasure in his work. 9 Series delivers fast precision by combining smoother hydraulics with wider view and less stress. The innovative negative hydraulic system combines straightforward technology with superior response.



*Photo may include optional equipment.

Computer Aided Power

The advanced CAPO (Computer Aided Power Optimization) system tunes engine and pump power to optimum levels. Multiple mode selections are implemented for specific applications, maintaining high performance while reducing fuel consumption. Additional features include auto deceleration and power boost. The LCD-display monitors engine speed, coolant and hydraulic oil temperature and through the self-diagnostic capability, it displays current error codes. Operators can set their own preferences for boom or swing priority and power mode selection at the touch of a button.

Power Mode

Three unique power modes provide the operator with custom engine power and fuel economy. Power-mode maximizes machine speed and power for maximum productivity. Standard-mode provides a reduced, fixed rpm for optimum performance and improved fuel economy. Economy-mode provides precise flow and engine power based on load conditions, for maximum fuel efficiency and controllability.

User Mode

Some jobs require more precise machine settings; some operators prefer different machine settings. Using the User-mode, the operator can customize engine speed, pump output, idle speed and other machine settings according to personal preferences.

Improved Hydraulic System



To achieve optimum precision, Hyundai redesigned the hydraulic system to provide the operator with super fine touch and top level controllability. Spool valves in the control valve are engineered to provide more precise flow to each function with less effort. Improved hydraulic valves, variable volume piston pumps, fine-touch pilot controls and enhanced travel functions make any operator look like a smooth operator. Newly improved features

include arm and boom regeneration, enhanced control valve technology and innovative auto boom and swing priority for best performances in any application.



Auto Boom vs. Swing Priority

This smart function adapts the ideal hydraulic flow balance for the boom and swing operation for your application. The advanced CAPO system monitors the hydraulic operations and adjusts the balance to maximize performance and productivity.

Performance



An operator, who can rely on his machine, takes pleasure in his work. 9 Series stands for lasting performance in strength, speed and reliability. The Auto boom-swing priority results into faster movements and shorter cycle times.

*Photo may include optional equipment.



Full Track Rail Guard & Adjusters

Durable full track rail guards keep tracks in place. Track adjustment is made easy with standard grease cylinder track adjusters and shock absorbing springs.

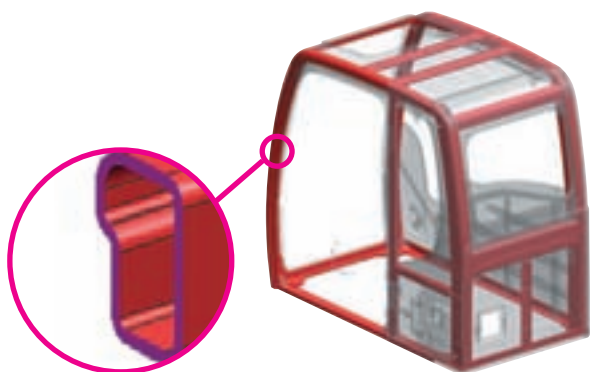

Structural Strength

The 9 series cabin structure is designed with slimmer but stronger tubing for more safety and better visibility. Low-stress and high-strength steel is welded to form a strong and stable lower frame. Structural durability is analyzed and tested by FEM-analysis (Finite Elements Method) and long-term durability tests.

CUMMINS QSK23-C Engine

The EU Stage II compliant, six cylinder, turbo-charged, 4 cycle, water cooled, Cummins QSK23-C diesel engine is built for power, reliability and efficiency.

Heavy-duty strength

The QSK23-C combines rugged productivity with a high power density and advanced engine management technology to deliver the lowest operating cost per ton of any mining engine in its class. Its high-pressure injection (HPI) fuel system (up to 29,000 psi / 200,000 kPa) results in more complete combustion for superior engine response across the entire power curve and the lowest fuel consumption in its class. Its compact and balanced in-line six-cylinder design and proven durability make it a great choice for the toughest mine sites. The one-piece Ferrous Cast Ductile (FCD) iron pistons and robust cylinder head work to improve long-term durability and dependability. A one-piece cast-iron block, forged-steel crankshaft and a large-diameter camshaft ensure long, reliable performance between overhauls, with the capability of multiple rebuild cycles.



Profitable

An owner, who knows his machine saves money, takes pleasure in owning it. 9 Series excavators contribute to your business as a time, fuel, spare-part and cost saving earthmoving solution. The Remote Management System allows machine owners to track, monitor and manage at a distance.



*Photo may include optional equipment.

Easy Access

Concentrated engine filters, remote type fuel pre-filter and a central grease system, combined with wide open compartments makes servicing the 9-series a pleasure for your mechanics.



Hi-mate (Remote Management System)

Hi-mate, Hyundai's newly developed remote management system, using GPS-satellite technology, provides our customers with the highest level of service and product support. Hi-mate enables machine owners to follow-up machine performance, to verify machine location and to access diagnostic information on a distance through any internet connection.

Enhanced Safety

Variable cabin guards offer enhanced operator safety. Additional working lamps on the cab improves operator convenience at night time. Wide cat-walks, large handrails and anti-slip plates provide easy and safe access to the cab and during maintenance.

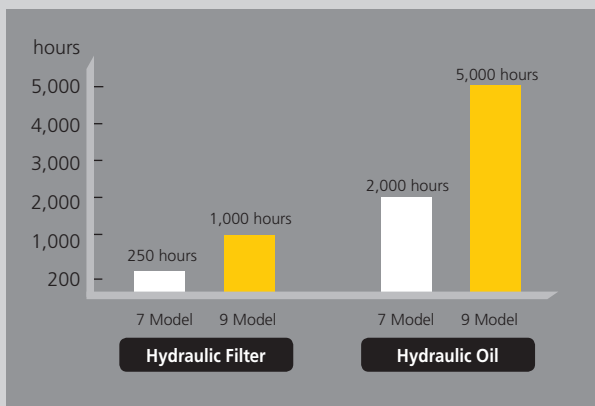

Extended Life of Components

New long-life bushings are designed for extended lube intervals. Wear-resistant polymer shims reduce noise and reduce wear of bushings. Extended-life hydraulic filters last up to 1,000 hrs and new long-life hydraulic oil need only be changed every 5,000 hrs.

Specifications

ENGINE

MODEL	CUMMINS QSK23-C		
Type	Water cooled, 4 cycle Diesel, 6-Cylinders in line, direct injection, turbocharged, charged air cooled and low emission		
Rated flywheel horse power	SAE	J1995 (gross)	760 HP (567 kW) / 1,800 rpm
		J1349 (net)	740 HP (552 kW) / 1,800 rpm
	DIN	6271/1 (gross)	771 PS (567 kW) / 1,900 rpm
		6271/1 (net)	750 PS (552 kW) / 1,800 rpm
Max. torque	353.7 kgf.m (2,558 lbf.ft) / 1,350 rpm		
Bore x stroke	170 mm x 170 mm (6.69" x 6.69")		
Piston displacement	23,000 cc (1,404 in ³)		
Batteries	4 x 12 V x 160 AH		
Starting motor	2 x 24 V; 7.5 kW		
Alternator	24 V; 75 Amp		

HYDRAULIC SYSTEM

MAIN PUMP	
Type	Variable displacement axial piston pumps
Max. flow	2 x 490 l/min (129.4 US gpm / 107.8 UK gpm)
Sub-pump for pilot circuit	Gear pump
Cross-sensing and fuel saving pump system	

HYDRAULIC MOTORS

Travel	Two speed axial piston motor with brake valve and parking brake
Swing	Axial piston motor with automatic brake

RELIEF VALVE SETTING

Implement circuits	320 kgf/cm ² (4,550 psi)
Travel	350 kgf/cm ² (4,980 psi)
Power boost (boom, arm, bucket)	350 kgf/cm ² (4,980 psi)
Swing circuit	300 kgf/cm ² (4,270 psi)
Pilot circuit	40 kgf/cm ² (570 psi)
Service valve	Installed

HYDRAULIC CYLINDERS

No. of cylinder bore x stroke	Boom : 2 - 230 x 2,165 (9.1" x 85.2")
	Arm : 1 - 260 x 2,180 mm (10.2" x 85.8")
	Bucket : 1 - 240 x 1,792 mm (9.4" x 70.6")

DRIVES & BRAKES

Drive method	Fully hydrostatic type
Drive motor	Axial piston motor, in-shoe design
Reduction system	Planetary reduction gear
Max. drawbar pull	70,200 kgf (154,800 lbf)
Max. travel speed (high / low)	3.2 km/hr (2.0 mph) / 2.3 km/hr (1.4 mph)
Gradeability	35° (70 %)
Parking brake	Multi wet disc

CONTROL

Pilot pressure operated joysticks and pedals with detachable lever provide almost effortless and fatigueless operation.

Pilot control	Two joysticks with one safety lever (LH): Swing and arm (RH): Boom and bucket (ISO)
Traveling and steering	Two levers with pedals
Engine throttle	Electric, Dial type

SWING SYSTEM

Swing motor	Axial piston motor
Swing reduction	Planetary gear reduction
Swing bearing lubrication	Grease-bathed
Swing brake	Multi wet disc
Swing speed	5.6 rpm

COOLANT & LUBRICANT CAPACITY

Refilling	liter
Fuel tank	1,450
Engine coolant	50.0
Engine oil	63.0
Swing device - gear oil	8.0
Final drive (each) - gear oil	20.0
Hydraulic system (including tank)	1,160
Hydraulic tank	670

UNDERCARRIAGE

The X-leg type center frame is integrally welded with reinforced box-section track frames. The undercarriage includes lubricated rollers, idlers, track adjusters with shock absorbing springs and sprockets, and a track chain with double or triple grouser shoes.

Center frame	X - leg type
Track frame	Pentagonal box type
No. of shoes on each side	52
No. of carrier rollers on each side	3
No. of track rollers on each side	8
No. of rail guards on each side	2

OPERATING WEIGHT (APPROXIMATE)

Operating weight, including 7,550 mm (24' 9") boom; 3,400 mm (11' 2") arm, SAE heaped 6.7 m³ (8.76 yd³) bucket, lubricant, coolant, full fuel tank, full hydraulic tank, and all standard equipments.

MAJOR COMPONENT WEIGHT

Upperstructure	11,960 kg (26,370 lb)
Boom (with arm cylinder)	11,900 kg (26,230 lb)

OPERATING WEIGHT

Shoes		Operating weight	Ground pressure
Type	Width mm (in)	kg (lb)	kgf/cm ² (psi)
Double grouser	700 mm (28")	118,000 (260,140)	1.51 (21.47)
	800 mm (32")	118,110 (260,390)	1.34 (19.05)
	900 mm (36")	118,220 (260,630)	1.19 (16.92)

BUCKET

bucket is welded with high-strength steel.

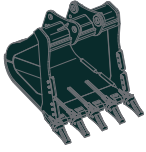

SAE heaped m³ (yd³) 6.7 (8.76)

Capacity m ³ (yd ³)		Width mm (in)		Weight kg (lb)	Recommendation mm (ft.in)
SAE heaped	CECE heaped	Without sidecutters	With sidecutters		7,550 (24' 9") Boom
6.70 (8.76)	5.88 (7.69)	2,390 (94.1)	-	5,864 (12,930)	3,400 (11' 2") Arm

- : Applicable for materials with density of 2,000 kg/m³ (3,370 lb/yd³) or less
- : Applicable for materials with density of 1,600 kg/m³ (2,700 lb/yd³) or less
- ▲ : Applicable for materials with density of 1,100 kg/m³ (1,850 lb/yd³) or less

ATTACHMENT

Boom and arm are welded with a low-stress, full-box section design. 7,550 mm (24' 9") boom and 3,400 mm (11' 2") arm are available.

DIGGING FORCE

Boom	Length	mm (ft.in)	7,550 (24' 9")	Remarks
	Weight	kg (lb)	10,310 (22,730)	
Arm	Length	mm (ft.in)	3,400 (11' 2")	
	Weight	kg (lb)	4,005 (8,830)	
Bucket digging force	SAE	kN	511.9 [558.5]	[]: Power Boost
		kgf	52,200 [56,950]	
		lbf	115,080 [125,540]	
	ISO	kN	581.5 [634.4]	
		kgf	59,300 [64,690]	
		lbf	130,730 [142,610]	
Arm crowd force	SAE	kN	423.7 [462.2]	
		kgf	43,200 [47,130]	
		lbf	95,240 [103,900]	
	ISO	kN	429.5 [468.6]	
		kgf	43,800 [47,780]	
		lbf	96,560 [105,340]	

Note: Boom weight includes arm cylinder, piping, and pin

Arm weight includes bucket cylinder, linkage, and pin

Dimensions & Working Range

DIMENSIONS R1200-9

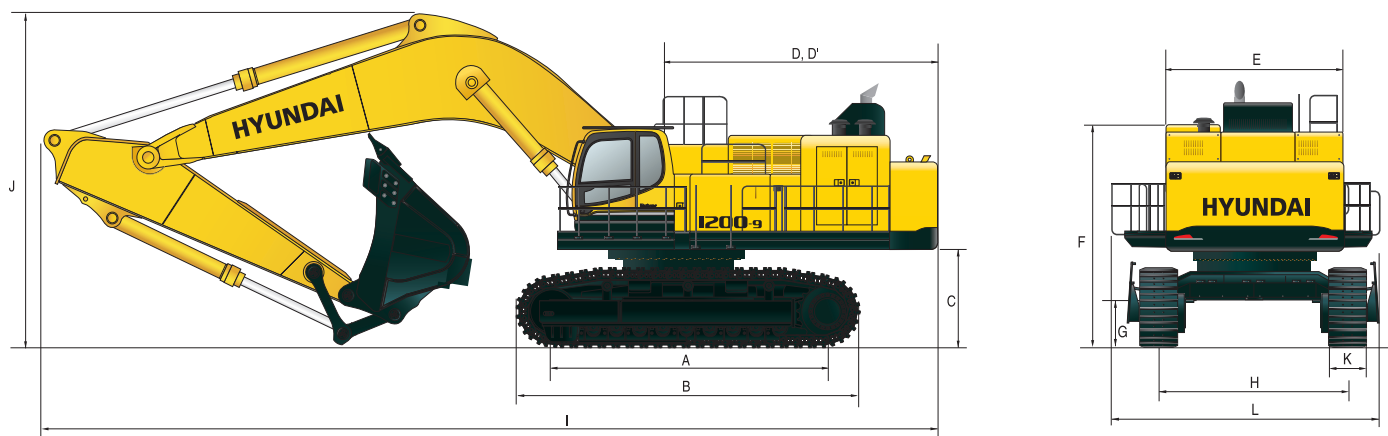

mm (ft · in)

mm (ft · in)

A Tumbler distance	5010 (16' 5")	Boom length	7550 (24' 9")
B Overall length of crawler	6400 (20' 12")	Arm length	3400 (11' 2")
C Ground clearance of counterweight	1825 (5' 12")	I Overall length	14580 (47' 10")
D Tail swing radius	4870 (15' 12")	J Overall height of boom	6210 (20' 4")
D' Rear-end length	4805 (15' 9")	K Track shoe width	700 (2' 4")
E Overall width of upperstructure	3520 (11' 7")	L Overall width	5560 (18' 3")
F Overall height of cab	4250 (13' 11")		
G Min. ground clearance	990 (3' 3")		
H Track gauge	3900 (12' 10")		

mm (ft · in)

WORKING RANGE R1200-9

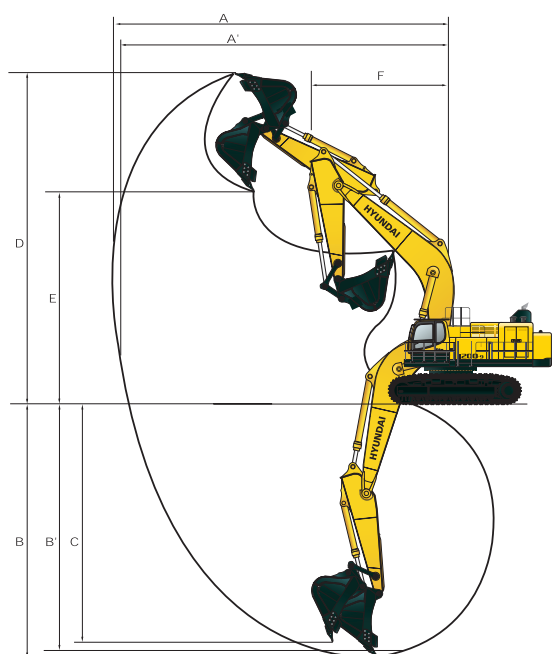















Boom length	7550 (24' 9")
Arm length	3400 (11' 2")
A Max. digging reach	13760 (45' 2")
A' Max. digging reach on ground	13380 (43' 11")
B Max. digging depth	8010 (26' 3")
B' Max. digging depth (8' level)	7840 (25' 9")
C Max. vertical wall digging depth	5230 (17' 2")
D Max. digging height	12420 (40' 9")
E Max. dumping height	7840 (25' 9")
F Min. front swing radius	6550 (21' 6")

Lifting Capacities

R1200-9

 Rating over-front  Rating over-side or 360 degrees

Boom : 7.55 m (24' 9") / Arm : 3.40 m (11' 2") / Bucket : 6.70 m³ (8.76 yd³) SAE heaped / Shoe : 700 mm (28") double grouser

Load point height m (ft)		Load radius										At max. reach				
		3.0 m (10 ft)		4.5 m (15 ft)		6.0 m (20 ft)		7.5 m (25 ft)		9.0 m (30 ft)		10.5 m (35 ft)		Capacity		Reach
																m (ft)
9.0 m (30 ft)	kg lb													*12990	*12990	11.22
7.5 m (25 ft)	kg lb								*19680	*19680	*6060	*6060		*28640	*28640	(36.8)
6.0 m (20 ft)	kg lb								*43390	*43390	*13360	*13360		*28460	*28460	(39.1)
4.5 m (15 ft)	kg lb								*21470	*21470	*13680	*13680		*13160	12140	12.33
3.0 m (10 ft)	kg lb								*47330	*47330	*30160	*30160		*29010	26760	(40.5)
1.5 m (5 ft)	kg lb								*36250	*36250	*27920	*27920		*22880	22750	12.53
Ground Line	kg lb			*52630	*52630	*40870	38600	*31210	26690	*24590	19690	*19550	15010	*14600	11950	11.82
-1.5 m (-5 ft)	kg lb	*47300	*47300	*116030	*116030	*90100	85100	*68810	58840	*54210	43410	*43100	33090	*32190	26350	(38.8)
-3.0 m (-10 ft)	kg lb	*49630	*49630	*8120	38060	*29560	26110	*23150	19270					*13620	13510	11.08
-4.5 m (-15 ft)	kg lb	*104280	*104280	*109420	*109420	*84040	83910	*65170	57560	*51040	42480			*30030	29780	(36.4)
-6.0 m (-20 ft)	kg lb	*52360	*52360	*42230	*42230	*33290	*33290	*26020	*26020	*19800	19280			*11570	*11570	10.01
		*115430	*115430	*93100	*93100	*73390	*73390	*57360	*57360	*43650	42510			*25510	*25510	(32.8)
		*37090	*37090	*31790	*31790	*25700	*25700	*19620	*19620					*6850	*6850	8.43
		*81770	*81770	*70080	*70080	*56660	*56660	*43250	*43250					*15100	*15100	(27.7)
						*13170	*13170									
						*29030	*29030									

1. Lifting capacity is based on SAE J1097, ISO 10567.
2. Lifting capacity of the Robex Series does not exceed 75% of the tipping load with the machine on firm, level ground or 87% of full hydraulic capacity.
3. The load point is a hook located on the back of the bucket.
4. (*) indicates the load limited by hydraulic capacity.

STANDARD EQUIPMENT

ISO Standard cabin

All-weather steel cab with 360° visibility
Safety glass windows
Rise-up type windshield wiper
Sliding fold-in front window
Sliding side window
One key fits all lockable doors
Hot & cool box
Storage compartment & Ashtray
Cabin roof-steel cover
Radio / MP3 Player
12 volt power outlet (24V DC to 12V DC converter)
Handsfree mobile phone system with USB-charging device
Sun visor

Cabin FOPS/FOG (ISO/DIS 10262)

FOPS (Falling Object Protective Structure)
FOG (Falling Object Guard)

Cabin lights

Computer aided power optimization (New CAPO) system

3-power modes, 2-work modes, User mode
Auto & one-touch deceleration system
Auto warm-up system
Overheat prevention system

Automatic climate control

Full automatic temperature controller
Defroster

Self-diagnostics system

Starting Aid (air grid heater) for cold weather

Centralized monitoring

LCD display

Engine speed or Trip meter
Clock
Gauges
- Fuel level gauge
- Engine coolant temperature gauge
- Hyd. oil temperature gauge
Warning lamps
- Engine warning
- Overload
- Communication error
- Low battery
- Air filter clogging
Indicators
- Max power
- Low speed/High speed
- Fuel warmer
- Auto deceleration

Two outside rearview mirrors

Fully adjustable suspension seat with seat belt

Adjustable joysticks

Console box tilting system

Six front working lights, two rear lights

Electric horn

Batteries (4 x 12V x 160 AH)

Battery master switch

Removable clean-out dust net for cooler

Automatic swing brake

Automatic fuel line deaeration

Fuel pre-filter with fuel warmer

Boom holding system

Arm holding system

Track shoes (700 mm; 28")

Full Track rail guard

Accumulator for lowering work equipment

Lower frame under cover

Travel alarm

OPTIONAL EQUIPMENT

Fuel filler pump (50 ℓ/min)

Beacon lamp

Rain guard - front window

Track shoes

Double grousers shoe (800 mm; 32")
Double grousers shoe (900 mm; 36")

Coolant pre-heating system

Rearview camera

Seat

Adjustable air suspension seat
Adjustable air suspension seat with heater
Mechanical suspension seat

Automatic lubrication

Cabin front guard

Wire net
Fine net

Hi-mate (Remote Management System)

- * Standard and optional equipment may vary. Contact your Hyundai dealer for more information. The machine may vary according to international standards.
- * The photos may include attachments and optional equipment that are not available in your area.
- * Materials and specifications are subject to change without advance notice.
- * All imperial measurements rounded off to the nearest pound or inch.

PLEASE CONTACT

